

| POLE SHAFT SPECIFICATIONS | | | | |
|----------------------------------|---|-------------------|------------------|-----------------|
| 1. | SHAFTS ARE ONE SECTION DESIGN FABRICATED FROM 6063 T6 ALUMINUM EXTRUSION-SPUN TAPERED. | | | |
| 2. | BASE CASTING IS 356 T6 ALUMINUM. THE SHAFT TELESCOPES INTO THE BASE CASTING AND IS CIRCUMFERENTIALLY WELDED TOP AND BOTTOM. | | | |
| 3. | ANCHOR BOLTS ARE "L" FORMED RODS HAVING A MINIMUM YIELD STRENGTH OF 55,000 P.S.I. FABRICATED FROM ASTM F1554 GR. 55 THEN FULLY GALVANIZED PER ASTM A153 SPECIFICATIONS AND FURNISHED COMPLETE WITH 2 HEX NUTS AND 2 FLAT WASHERS. | | | |
| 4. | POLES SHALL HAVE A POLYESTER POWDER COAT FINISH IN A STANDARD COLOR. | | | |
| POLE DIMENSIONS | | | | |
| POLE HGT. (FT.) | TOP DIA. (IN.) | BOTTOM DIA. (IN.) | GAGE | MTG. HGT. (FT.) |
| 12' | 3.00 | 5.00 | .125 | 12' |
| BASE PLATE DIMENSIONS | | | | |
| BOLT CIRCLE (IN.) | BASE PLATE DIM. (IN.) | BOLT HOLE (IN.) | PLATE THK. (IN.) | |
| 7.50-9.00 | 10.75 SQ | .81 | .75 | |
| ANCHOR BOLT DIMENSIONS | | | | |
| ANCHOR BOLT DIA. (IN.) | ANCHOR BOLT LENGTH (IN.) | | | |
| .75 | 20.00 | | | |
| ALLOWABLE WIND LOADING (SQ. FT.) | | | | |
| WIND* EPA | 80 MPH | 90 MPH | 100 MPH | 120 MPH |
| | 12.5 | 9.5 | 7.4 | 4.7 |

*WITH 1.3 GUST FACTOR

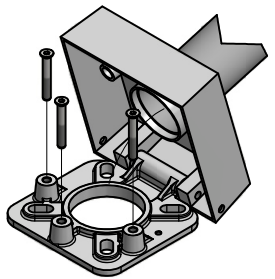

BASE ROTATION DETAIL VIEW

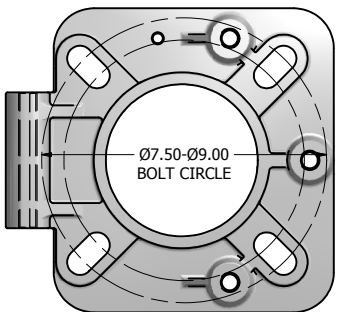

10.75 SQ.

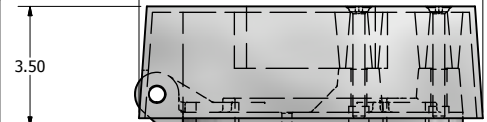

10.75 X 10.75 X 3.50 THK. BASE CASTING

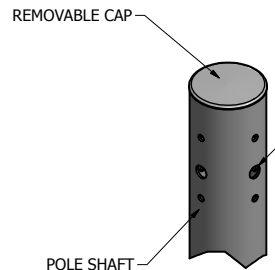

DRILLED MOUNT OPTIONS

DRILLED PER FIXTURE REQUIREMENTS:
 D1- DRILLED FOR 1 FIXTURE
 D2- DRILLED FOR 2 FIXTURES AT 90° OR 180°
 D3- DRILLED FOR 3 FIXTURES AT 90° OR 120°
 D4- DRILLED FOR 4 FIXTURES

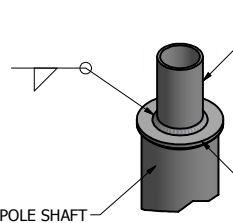

TENON MOUNT OPTIONS

TENON MOUNT OPTIONS:
 T2- Ø2.38 OD X 4.00 LG
 T3- Ø3.00 OD X 5.00 LG
 T4- Ø4.00 OD X 6.00 LG

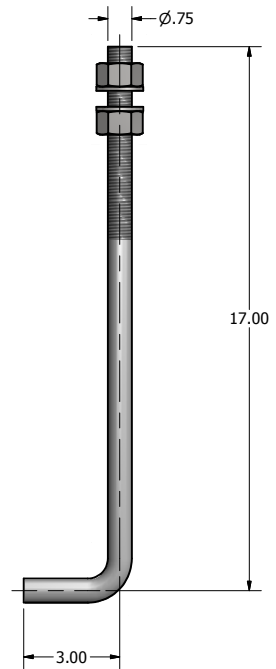

Ø.75 X 20.00 ANCHOR BOLT

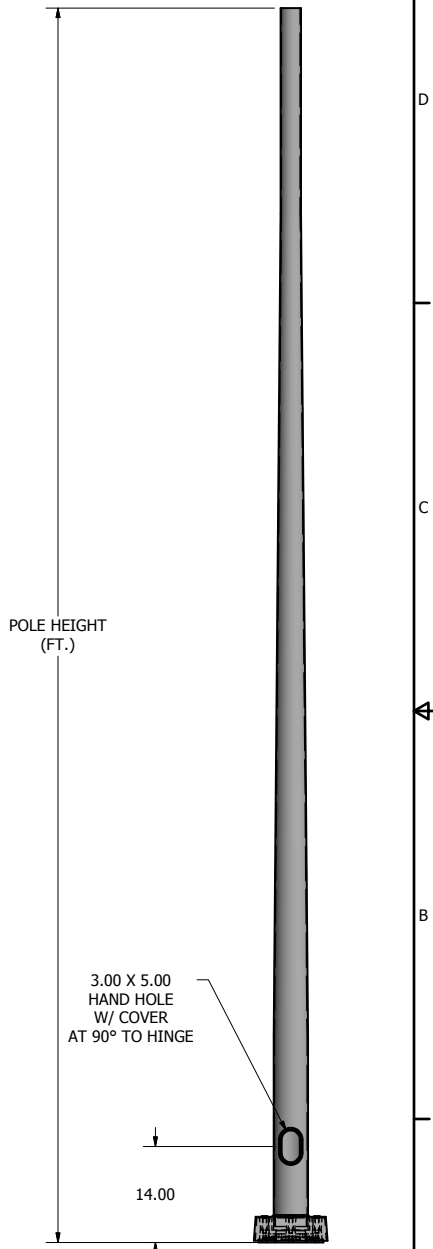

POLE DETAIL

lyte poles
 a DWM company

P.O. Box 340
 Eastpointe, MI 48021
 P: (586) 771-4610 | F: (586) 771-5527
 www.lytepoles.com

| | |
|-------------------|-------------|
| DRAWN: M. HARVALA | 2/13/2015 |
| CHECKED | |
| REVISION: | DATE: |
| APPROVED: | |
| QUOTE: | |
| S.O.# | |
| REF: | SCALE: NONE |

| | |
|---|--------|
| SOME GEOGRAPHICAL AREAS HAVE SPECIAL WIND CONDITIONS THAT CAN CREATE WIND INDUCED VIBRATIONS CAUSING A FATIGUE PROBLEM. NO METHOD HAS YET BEEN FOUND FOR PREDICTING DESTRUCTIVE LIGHTING POLE VIBRATION. THESE CONDITIONS ARE UNIQUE AND CANNOT BE GUARANTEED AGAINST, AND ARE THE RESPONSIBILITY OF A LOCAL SITE ENGINEER. | |
| TITLE: | |
| CATALOG: | |
| DWG NO: 505-5012-12 | SIZE C |
| SHEET 1 OF 1 | |

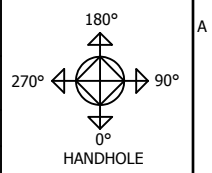

example order number

| Fixture | | | Catalog Number | | | Mounting Type | Fixture Mounting Arrangement | Finish | Options | | | Accessories | | | |
|---------|---------|--------|----------------|------------|----------------|---------------|------------------------------|--------|-----------------|--------|-------------|------------------|--------|-------------|------------------|
| Brand | Product | Number | Design | Shaft Size | Wall Thickness | | | | Mounting Height | Design | Orientation | Height From Base | Design | Orientation | Height From Base |
| | | | 101 | 40 | 11 | 20 | AB | T2 | DB | WB-15 | @90 | 10' | FH | @180 | 9' |

build your order number

| Fixture | | | Catalog Number | | | Mounting Type | Fixture Mounting Arrangement | Finish | Options | | | Accessories | | | |
|---------|---------|--------|----------------|------------|----------------|---------------|------------------------------|--------|-----------------|--------|-------------|------------------|--------|-------------|------------------|
| Brand | Product | Number | Design | Shaft Size | Wall Thickness | | | | Mounting Height | Design | Orientation | Height From Base | Design | Orientation | Height From Base |
| | | | | | | | | | | | | | | | |
| | | | | | | | | | | | | | | | |

mounting type

AB = Anchor Base
EMB = Embedded (Direct Burial)

fixture mounting arrangement

| | |
|---------|------|
| D1 | D4 |
| D2@90 | T2 |
| D2@180 | T2.5 |
| D3@90 | T3 |
| D3@120* | T4 |

finish

WH = White
TWH = Textured White
DB = Dark Bronze
TMB = Textured Medium Bronze
HB = Harvest Bronze
NB = New Bronze
SL = Silver
MGY = Medium Gray
GR = Gray
TGR = Textured Gray
GM = Graphite Metallic
DP = Dark Platinum
MA = Matte Aluminum
PSP = Platinum Silver
BK = Black
TBK = Textured Black
MG = Moss Green

options

CMB = Camera Mounting Bracket
CMP = Camera Mounting Plate
WB-15 = Mounting Bracket
WC = Welded Coupling (denote size)
WN = Welded Nipple (denote size)
Festoon = Festoon Provision
CSBC = Custom Steel Base Cover
VD = Vibration Dampener
GFCI/IUC = Ground Fault Circuit Interrupter with In-Use Cover
UL = UL Listed

Note: N/A = Not Applicable

accessories

TB = Transformer Base*
ABS-BC = ABS Base Cover*
LW = Lowering Winch
LW-ELECTRIC = Electric Lowering Winch
BA = Banner Arm
FH = Flag Holder
PTTA = Pole Top Tenon Adapter*

*Round poles only

Refer to the Mounting Orientation Guide on the next page of this file.

Contact us for custom colors.

*See our online product catalog for complete catalog numbers of these options and accessories.

** UL Listed labeling is available for catalog steel and aluminum poles—both Commercial & Industrial and Roadway. UL Listed labeling is not available for brackets. UL Listing must be specified at the time of order.